

Original article

# Application of intelligent well completion in optimising oil production from oil rim reservoirs

Eric Broni-Bediako<sup>✉</sup>\*, Naziru Issaka Fuseini, Richard Nii Ayitey Akoto, Eric Thompson Brantson

*Petroleum Engineering Department, University of Mines and Technology, Tarkwa, Ghana*

(Received August 31, 2019; revised September 6, 2019; accepted September 12, 2019; available online September 22, 2019 )

**Citation:**

Broni-Bediako, E., Fuseini, N.I., Akoto, R.N.A., Brantson, E.T. Application of intelligent well completion in optimising oil production from oil rim reservoirs. *Advances in Geo-Energy Research*, 2019, 3(4): 343-354, doi: 10.26804/ager.2019.04.01.

**Corresponding author:**

\*E-mail: ebronibediako@umat.edu.gh

**Keywords:**

Conventional well  
intelligent well completion  
oil rim reservoir  
reactive control strategy  
water coning

**Abstract:**

Intelligent well application has proven useful in maximising oil production from oil rim reservoirs. Intelligent wells are equipped with downhole sensors and surface controlled downhole inflow control valves (ICVs) which should be strategically controlled by the operator. Challenges however arise in determining the best reactive control strategy (RCS). This paper seeks to develop an effective RCS (algorithm) that will maximise oil production and to ascertain how the proposed RCS will fare when porosity, permeability, oil-water contact and skin factor change. An anticlinal oil rim reservoir with a horizontal well was modelled and run using ECLIPSE 100. The well was later made intelligent by installing ICVs and a RCS was designed to control the valves. Three RCS were proposed but the algorithm that produced the maximum cumulative oil was selected to be the optimal. The intelligent well yielded more cumulative oil and gas than the conventional horizontal well. It also delayed water breakthrough and reduced cumulative water production. Sensitivity analysis on porosity, permeability and skin positively affects the developed reactive control strategy whereas oil water contact variations yielded poor results. Economic analysis of the intelligent well for 20 years showed that the application of the intelligent well completion in the oil rim reservoir was profitable.

## 1. Introduction

Oil reservoirs are always characterised by production problems during the life of the reservoir. Depending on the type of problem, appropriate techniques are required to solve them. Some of the problem faced during oil production are, gas cusping problems, water control problems, permeability impairments, equipment failures and several others. An inherent problem that is associated with production of oil from oil rim reservoirs is early production of water as well as gas cusping. Early water production from an oil rim reservoir causes corrosion of tubulars, scale/salt deposition, gas hydrate formation, disposal problems of the water itself and high cost of lifting the water (Anon, 2016). The production of oil is usually expected after millions of dollars and several man-hours is spent in developing a reservoir. However, production engineers are faced with problems in dealing with unwanted fluid such as gas and water in oil rim reservoirs as they produce the oil (Sarkodie et al., 2014). Water production during the life of a well is inevitable but early and massive production of the water can be managed. Having to identify the cost-effective method of managing water production and gas

cusping has always been the problem of a production engineer whose aim is to maximize oil production, hence the need to devise methods of delaying and/or minimising water and gas production (Sarkodie et al., 2014).

The petroleum sector has over the years been pursuing the implementation of remotely controlled and monitored well completion termed, intelligent well completion (IWC). It enables a producer to effectively monitor and shut valves at desired locations (Robinson, 2003).

The intelligent well technology is one of the most important technologies needed in reservoir optimisation, increasing recoverable reserves, enhancing oil recovery and reducing water cut. In 1997, Saga Petroleum installed the first ever intelligent well technology in the world. This technology has hitherto achieved a widespread implementation and development in almost all parts of the world (Huang et al., 2011). However, IWC is faced with issues of longevity, reliability and high cost attached to its usage. It is therefore necessary to evaluate the following factors before considering the implementation of IWC. Equipment diameters and available space, fluid velocity, pressure drop and erosion. It is also important to evaluate and establish means of protecting sensors, cables and control lines



of the IW system (Mahmood et al., 2018).

Optimisation methods (control techniques) are applied to intelligent well technology to balance production along the wellbore length, control water breakthrough, and ensure early economic oil production (Masoudi et al., 2013). The control strategies include open and closed loop. Closed loops are further classified as either feedback (reactive) or proactive. The most commonly used inflow control approach is the 'proactive' closed-loop strategy (Dilib et al., 2015). Raoufi et al. (2015) proposed an optimisation algorithm based on simulated annealing (SA) algorithm to obtain an optimum control strategy and determining an operation that maximises the net present value (NPV). This algorithm ensures that, the water that is being produced does not exceed the desired limit for water production. The path followed by the SA algorithm for finding the optimum results yielded about 13.91% increase in cumulative oil and a decline of 31.89% in cumulative water production.

Raoufi in one of his publications titled "optimisation of flow control with intelligent well completion in a channelised oil rim reservoir" in 2011, developed a mathematical model based on the trust region method. As part of his work, he compared three control strategies used in optimisation of production from oil rim reservoirs. These include fixed flow control devices, ON/OFF control valves, and infinitely variable control devices. The comparison of the valve control strategies indicated that, the ON/OFF control valve algorithm yields the best cumulative oil production. In the ON/OFF valve control strategy, the inflow control valves (ICV) are installed at positions to trigger oil production and stop water production based on pre-set values. Adekunle (2012) proposed an algorithm to optimise oil production from oil rim reservoirs. His method was based on what he called "trial and error method". He used data simulation models from oil rim field called chevron X field but he did not disclose the data due to confidentiality. The Schlumberger reservoir simulator was his choice of tool in modelling the reservoir. He implemented Darcy's flow rate equation into the eclipse software "WCONPROD" keyword under the "Schedule" section and set the flow rate to the maximum value. Modelling for Open/Shut ICDs with the Schlumberger Eclipse 100 simulator was achieved by applying the CECON keyword in the SCHEDULE section to set a water cut limit of 90%, at which the errant connections are automatically SHUT. Simulations were run on the basis of trial and error by varying the "WCONPROD" keyword for three different oil production rates, that is 5,000 stb/day, 7,500 stb/day and 10,000 stb/day. Based on the result, the IWC producing at 10,000 stb/day proved optimal. Under this production rate, there was 988.38 Mstb (5.41%) increase in Field Oil Production Total and a 0.6% increase in Field Oil Efficiency. However, Field water Production Total increased by 132.63 Mstb (17.81%) for IWC based on the trial and error method but it remained below the 90% economic limit set. Economic evaluation was done using net present value calculation of cash inflow-cash outflow to determine the economic value of the project if intelligent wells are used. The effect of uncertainties in variables such as labour, cost of equipment, raw materials and oil price can have major effect

on the evaluation of investment and the return on investments and as such, sensitivity analysis on some of these were carried out. He found out that, reduced oil price resulted in positive NPV but skin negatively affected production from IWC.

Several other control strategies have been proposed for various forms of reservoirs but important challenges still arise from developing an effective control strategy that will be applied on intelligent wells in order to optimise the production of oil from an oil rim reservoir. As such, this paper seeks to provide an effective and efficient RCS to tackle early water breakthrough and gas cusping from thin oil reservoirs so as to maximise oil production, by using a horizontal well with ICVs implemented at various segments of the well.

## 2. Resources and methods

### 2.1 Reservoir model description

The reservoir's geologic model used for this research was built using the Cartesian (block centred) grid system of the eclipse software, specifically ECLIPSE 100 (black oil model). Data used in the modelling of the thin oil rim reservoir was obtained from Chang (2014) and presented in Table 1. The oil rim reservoir is an anticlinal reservoir with a gas cap above and an inactive aquifer below it and it contains light oil within a column of 35 ft. In modelling the reservoir using ECLIPSE, 50 cells were used in both the x and y directions, and 20 cells in the z direction for simplicity and optimal run time. The dimensions of all the cells were made equal, having a length by width by height measurements of  $200 \times 200 \times 5$  respectively, so as to obtain the anticlinal shape. The reservoir is a homogenous reservoir with a uniform porosity of 0.2 and a permeability of 30 mD in x, y and z directions. The reservoir model had a total of 5,000 cells and it is located at a depth of 3,505 ft. Fig. 1 shows a diagram of the modelled anticlinal oil rim reservoir.

#### 2.1.1 Model initialisation

The geologic (static) model of the reservoir was converted into dynamic model by the rock saturations and fluid model. Since the reservoir contains water, oil and gas, both the water/

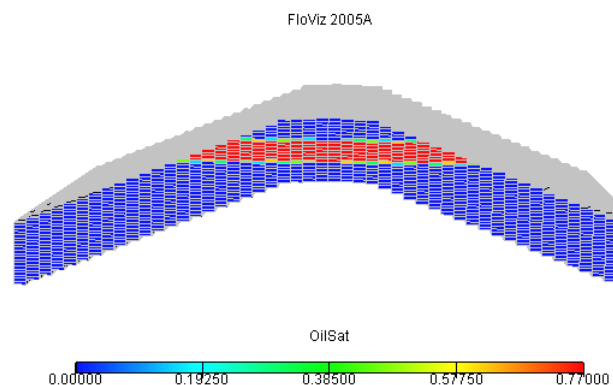
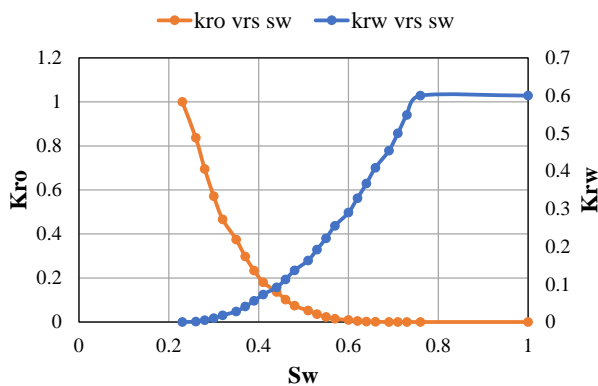
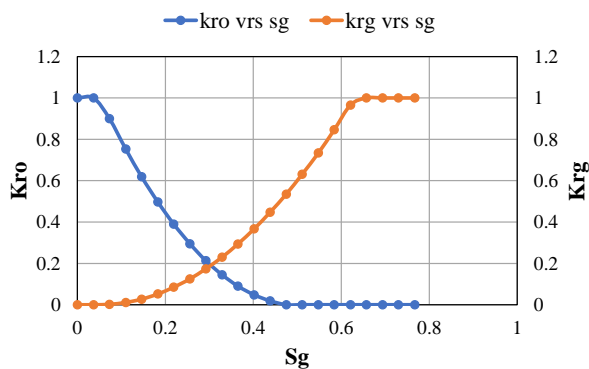

Fig. 1. Anticlinal oil rim reservoir.

**Table 1.** Main parameters of reservoir model.

Parameter	Value	Unit
Porosity	20	%
Horizontal permeability	30	mD
Vertical permeability	30	mD
Thickness	35	ft
Gas oil contact	3,505	ft
Water oil contact	3,540	ft
Oil API	48.8	API
Oil viscosity	1.01	cP
Oil formation volume factor	1.08	bbl/stb
Dimensions of reservoir	50 × 50 × 20	Grid blocks
Dimensions of grid block	200 × 200 × 5	ft <sup>3</sup>
Rock compressibility	3.14 × 10 <sup>-6</sup>	psi <sup>-1</sup>
Oil density	49.99	lb/ft <sup>3</sup>
Water density	63.698	lb/ft <sup>3</sup>
Gas density	0.050674	lb/ft <sup>3</sup>

**Fig. 2.** Oil-Water relative permeability curve.**Fig. 3.** Gas-Oil relative permeability curve.

oil saturation functions (SWOF) and the gas/oil saturation functions were needed to initialise the model. The reservoir contains live oil with dissolved gas-oil ratio of 1.5208 at

bubble point pressure of 4,351.1 psi. In addition to that, the reservoir also has a gas cap containing dry gas and its properties is described under the keyword PVTO in the model data. Its phase pressure is given as 200 psi at a viscosity of 0.012826 cP and gas formation volume factor of 15.54 ft<sup>3</sup>/scf. The reference pressure of the rock is 2,949 psi and the rock compressibility is given as 3.14 × 10<sup>-6</sup> psi<sup>-1</sup>. The initial oil saturation is 0.77 and its residual oil saturation is 0.24. The initial water and irreducible water saturations are 0.76 and 0.23, respectively. However, the initial oil saturation from the gas oil relative permeability is given as 0.475 and its residual saturation is 0.037. The initial gas saturation is 0.963 and its residual gas saturation is 0.525. The oil-water and gas-oil relative permeability curves for the fluids are shown in Figs. 2 and 3, respectively.

## 2.2 Well modelling and placement

A horizontal well named N1, with measured depth (MD) of 4,950 ft and a true vertical depth (TVD) of 3,350 ft was modelled using the WELSPEC keyword. A horizontal well was the preferred type of well for thin oil reservoirs due to the fact that they provide a large contact area with the thin oil column as opposed to vertical wells. The well was completed and perforated at seven regular intervals of 200 ft each, i.e., eight perforations using the COMPDAT keyword. The wells position was varied and simulations were done until the optimal position was obtained. The optimal position is the grid coordinates that yields the maximum oil recovery and also lies within the thin column of oil where coning is possible. Using the well control data keyword "WCONPROD", an oil flow rate target of 6,000 bbls/day and a bottom hole production target value of 250 psia was used in the simulation. Fig. 4 shows a horizontal well placed inside the reservoir.

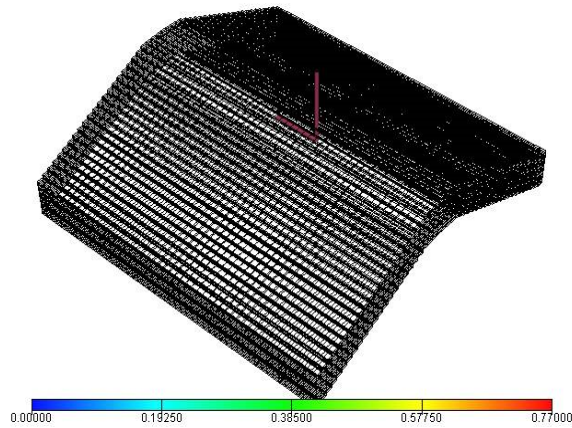

Fig. 4. Top view of the reservoir with the horizontal well.

### 2.3 Well segmentation

For valve placement in ECLIPSE, the horizontal well had to be divided into segments to enable the placement of the valves (Aitokheuhi, 2004). Well segmentation provides detailed analysis of fluid flow in horizontal and deviated wells. Flow rates of oil, water and gas at segments can be monitored and when the well is segmented. The keyword WELSEGS was used to define the segment structure of the horizontal well N1 in this research. The keyword has two main record fields, the first field describes the top segment (segment nearest to the wellhead) and sets some general flags. The second field can consist of one record if only one segment is to be defined, but in this paper, eight segment structures were described so that each perforation is allocated a single segment within a 200 ft length.

The segmenting was done in a way that each node of a segment lies within a connection (perforation). Prior to the segmenting, the keyword WSEGDIMS was used to set array dimensions for multi-segment wells. It defined the maximum number of multi-segment wells in the model, the maximum number of segments and the maximum number of branches per well. Fig. 5 shows a schematic diagram of multi segments well. The segments needed to be completed before installing the valves. The keyword COMPSEG and its related data records allowed for the completion of multi-segmented wells (a well with more than one segment). It defines the locations of completions in a multi-segment well and ECLIPSE software allocates each completion to a well segment (Muhammad, 2008).

### 2.4 Inflow control valve (ICV) modelling

Eclipse keyword “WSEGVAlV” was used under the SCHEDULE section to model inflow control valves and assign them to each segment. This keyword designates specific well segments to represent a sub-critical valve in a multi-segment well. This imposes an additional pressure drop in the segment due to flow through a constriction with a specified area of cross section. The pressure drop across the device is calculated by

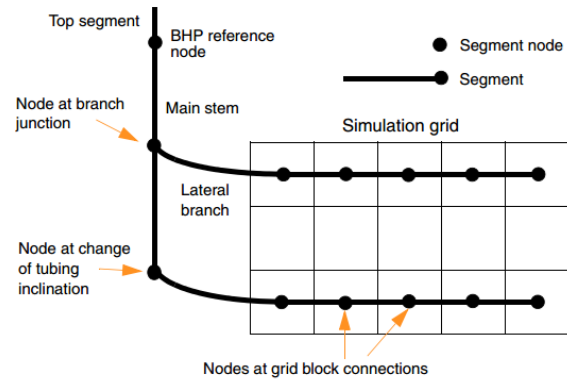

Fig. 5. A schematic of multi-segment well structure (Kumar et al., 2016).

ECLIPSE using a homogenous model of subcritical flow through a pipe constriction using the Eqs. (1) to (3) (Al-Ghareeb, 2009; Sampaio et al., 2012).

$$\delta P = \delta P_{cons} + \delta P_{fric} \quad (1)$$

$$\delta P_{cons} = C_u \frac{\rho v_c^2}{2C_v^2} \quad (2)$$

$$\delta P_{fric} = 2C_u f \frac{L^2}{D} \rho v_p^2 \quad (3)$$

where

$\delta_{fric}$  accounts for additional frictional pressure drop in valve segment (psi)

$\delta_{cons}$  accounts for the effects of the constriction (psi)

$C_u$  (unit conversion constant) =  $2.159 \times 10^{-4}$

$\rho$  = density of the fluid mixture, (lb/ft<sup>3</sup>)

$v_c$  = flow velocity of the mixture through the constriction (ft/s)

$C_v$  = dimensionless flow coefficient of valve

$f$  = Fanning friction factor

$l$  = Additional length of piping in segment (ft)

$D$  = Diameter of the pipe (not constriction) (ft)

$v_p$  = flow velocity of mixture through pipe(ft/s)

Several forms of ICVs exist and based on their operations, they are either categorised as fixed flow control devices, binary (ON/OFF) or infinitely variable ICV (Rauofi and Mashishi, 2011). The type of ICV used for this paper is the binary ICV due to the nature of the algorithm that will be developed. Binary ICV assume only two positions, that is, either fully open or fully closed. Binary ICVs also provide a firm control of both gas and water in various segments (Sarkodie et al., 2014). Hence, it was chosen as the best ICV for the intelligent well.

In modelling ICVs using ECLIPSE, eight records are needed to complete the model. The first is the well name on which the ICV is to be installed in, and for this work, the well name was “N1”. The second record is the segment number to contain the valve, the third is the dimensionless flow coefficient ( $C_v$ ) and the fourth is the cross sectional area of the constriction. The remaining records can be defaulted so that ECLIPSE takes them from the WELSEG data. Eight (8)

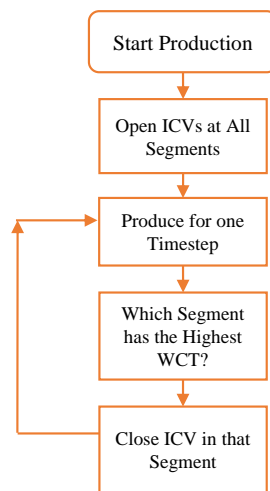

Fig. 6. A schematic of RCS 1 (Algorithm 1).

valves were installed at segments two (2) to nine (9) and they assumed a fully opened position of area 0.022 ft (3.168 square inch) with a  $C_v$  value of 0.66.

## 2.5 Development of a reactive control strategy

Developing an effective RCS to be applied on an intelligent well in oil rim reservoirs requires careful analysis and understanding of the reservoir characteristics and as such sequential steps were applied in developing the algorithm. The following steps detail how the algorithm was developed using the “ACTIONX” keyword in ECLIPSE. Other forms of control keywords exist in ECLIPSE and these include: ACTION, ACTIONS, ACTIONG, ACTIONW and ACTIONR but the choice of control keyword for this work is the ACTIONX keyword since it provides more flexibility and allows comparison of the well’s parameter against another. Unlike ACTION (G, R, S, W) which allows comparison of a well quantity against only a constant value. The ACTIONX keyword plays an integral part of developing an effective RCS since it specifies a set of keywords to be processed if a set of conditions are met (Amangaliyev, 2017). In this paper, since the main objective is to delay or if possible minimise water and gas production, the algorithm focused on mitigating water and gas production at various segments of the well.

The ACTIONX keyword is just like an “IF” condition used in various programming languages to write programmes. The keyword was placed under the schedule section of the data file and it was terminated with the keyword “ENDACTIO”. The ACTIONX facility of the simulator allows for nested conditions, hence complex “IF” conditions can be looped. To achieve an efficient RCS, several complex conditions were set and simulation runs to determine which algorithm will yield the maximum cumulative oil production and will yield the maximum NPV.

### 2.5.1 Algorithm development results

Three algorithms were developed based on critical analysis

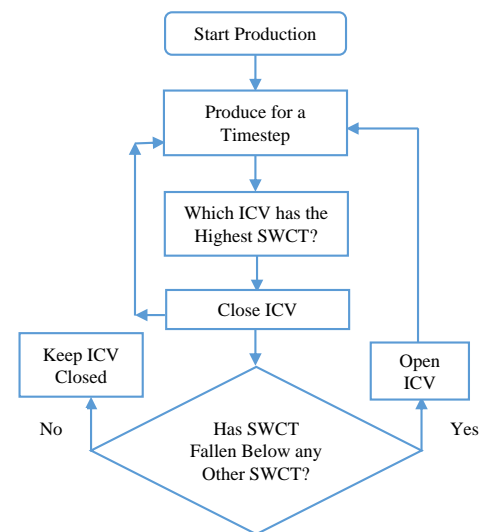

Fig. 7. A schematic of RCS 2 (Algorithm 2).

of the reservoir and the problems the algorithm intended to solve, which is water and gas coning and the most effective one was selected based on its ability to maximise oil production by controlling coning. Unlike produced water, gas is a desirable component which contributes revenue and so the algorithms targeted produce water reduction and also finding a way of delaying gas production. By delaying the production of gas in the reservoir, the gas provides a gas cap drive mechanism to aid oil production which is of much importance. The three reactive control strategies are detailed as follows.

### Algorithm 1 development process

The first algorithm was designed to specifically target water production in the segments of the well. The algorithm basically instructs all ICVs to open at the start of production and then to shut ICV in the segment that has the highest water cut amongst them all. That ICV is kept closed and production is carried out for a 30-day period after which all the ICVs are opened again and a query of which segment has the highest water cut (WCT) is made again. This was achieved by looping the set of instructions till the 20 years of production ends. Fig. 6 is a schematic of the second RCS that was coded into the model.

### Algorithm 2 development process

Algorithm 2 was designed to minimise the water cut in the segment that has the highest water cut. The algorithm opens all ICVs at the start of production and after 30 days, a query is carried out by the algorithm to determine which segment has the highest water cut. The ICV in that particular segment is instructed to close and production carried out for a month after which another query as to whether the segment water cut (SWCT) in that particular segment has fallen below any other SWCT. If yes, the closed ICV is now opened for a month of production but if no, the ICV is kept closed and produced for a month and repeated till production ends. A schematic of algorithm 2 is represented in Fig. 7.

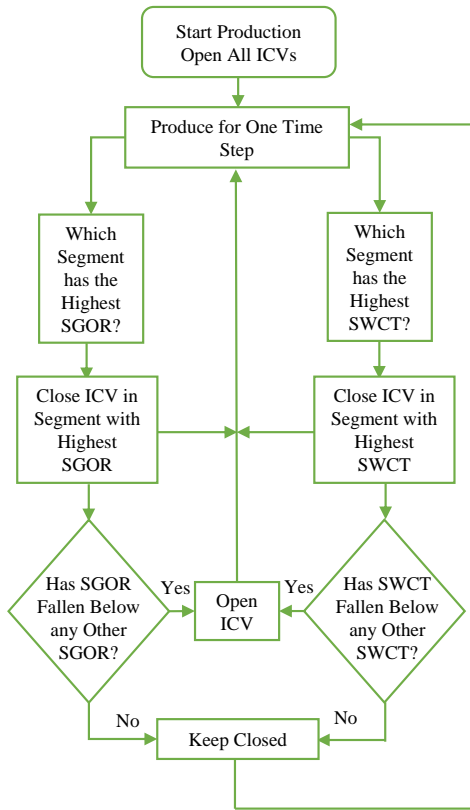

Fig. 8. A schematic of RCS 3 (Algorithm 3).

Table 2. Permeability and porosity values for the three cases.

Absolute permeability (mD)		
Best case	Base case	Worst case
60	30	15
Absolute porosity		
0.4	0.2	0.1

Algorithm 3 development process

Algorithm 3 was designed to open all ICVs and produce for a time step after which a query is made to find out which segment has the highest SWCT and SGOR. The ICV in that particular segment is then instructed to shut and another query is made to find out if the SWCT and SGOR in the identified segment have fallen below any SWCT and SGOR respectively in the other segments. If yes, the algorithm opens the ICV in the identified segment but if no, the algorithm keeps the ICV closed and production is carried out for one-time step. A schematic of algorithm 3 is represented in Fig. 8.

2.6 Sensitivity analysis

In order to satisfy uncertainties in the reservoir caused by changes in the reservoir fluid and rock properties, sensitivity analysis was carried out to determine the robustness of the selected algorithm. Sensitivity analysis is the study of how an

independent variable affects a particular dependent variable under a set of assumptions (Aduku, 2018). Dynamic and static reservoir parameters were varied at two extreme cases (best and worst cases). The two static reservoir parameters of importance in this work are absolute porosity and absolute permeability and the dynamic reservoir parameters are skin and oil water contact.

2.6.1 Static reservoir parameters

Porosity and permeability for two extreme cases (best and worst) were put into the model so as to determine how sensitive the algorithm is in relation to these variables. These two extreme case values were obtained by multiplying the base case porosity and permeability (porosity and permeability used in the main reservoir model) values by a factor of 2 and 0.5 to obtain the best case and worst case values. From Darcy’s law, a direct variation exists between flow rate and permeability, hence, there will be an increase in flow rate when the permeability of a reservoir increases (Tarek, 2010). However, there is no direct relationship between flow rate and porosity since a reservoir can have high porosity but cannot transmit flow due to low permeability. That notwithstanding, there is a generalisation that high porosity will usually result in high flow rate. Table 2 shows the porosity and permeability values used in all three cases.

2.6.2 Dynamic reservoir parameters

The robustness of the selected algorithm in the presence of formation damage (skin) was determined by varying the skin around the wellbore to extreme cases. In the presence of skin, the wellbore generates an additional pressure drop around it leading to low productivity index (Tarek, 2010). The productivity index is a mathematical means of expressing the ability of fluids to be delivered into the wellbore (Aulisa et al., 2011). The best case value which represents a stimulation was -2 and the worst case value which represents formation damage was +5. Simulation was carried out for 20 years at 5 years interval, and the well’s productivity index (PI) was monitored to see how the algorithm functioned under formation damage and when stimulation is carried out. Formation damage is related to pressure drawdown and PI by Eqs. (4) to (7).

$$\Delta P_{skin} = \frac{qp}{2\pi kh} s \tag{4}$$

$$P_e - P_{wf} = 141.2 \frac{q\mu B_o}{kh} \left( \ln \frac{r_e}{r_w} + s \right) \tag{5}$$

$$P_e - p_{wf} = \text{drawdown} \tag{6}$$

$$PI = \frac{q}{P_e - P_{wf}} \tag{7}$$

where

- q = oil flow rate (stb/day)
- k = permeability (mD)
- h = thickness (ft)
- s = skin factor

$p_e$  = external boundary reservoir pressure (psi)  
 $p_{wf}$  = flowing bottom hole pressure (psi)  
 $\mu$  = oil viscosity (cP)  
 $B_o$  = oil formation volume factor (bbl/stb)  
 $r_e$  = drainage radius (ft)  
 $r_w$  = wellbore drainage radius (ft)  
 $PI$  = productivity Index (STB/day/psi)

This implies that the additional pressure drop generated due to skin affects the productivity of the well and therefore, low PI is not desirable since it reduces the field of efficiency (FOE).

The oil water contact (OWC) of the reservoir was also varied so that the column of oil within the reservoir attains a value of 13 ft and 90 ft to depict the worst case and best case scenario. This dynamic reservoir property varies as production from the reservoir is carried out. The selected minimum and maximum values of the oil column depict theoretical values of the oil column that can exist in an oil rim reservoir. So, applying the IWC coupled with the selected algorithm (algorithm 3) on these oil columns was carried out to determine how the algorithm will fare as the size of the water column changes. To obtain the best case value, an optimistic OWC of 3,595 ft was used in the simulation and this value represents an oil column thickness of 90 ft, since the gas oil contact (GOC) is at 3,505 ft. For the worst case scenario, that is 13 ft oil column, an OWC at 3,518 ft was used in the model and simulation was run over 20 years. The cumulative water produced otherwise known as field water production total (FWPT) and field oil production total (FOPT) were analysed for the two extreme cases. Table 3 presents values of skin and oil-water contact under the circumstances.

### 2.7 Profitability of intelligent well completion

To determine the profitability of applying intelligent wells, the standard petroleum engineering profitability measure, net present value (NPV) was calculated. An economic model was built to aid in the evaluation of the NPV of the intelligent well. The model took into account the costs of drilling and completing an intelligent well, the cost of treating produced water and field operating expenditure. Since the oil rim reservoir contained gas and light oil, the income from producing oil and gas was calculated on yearly basis and then discounted over 20 years. The mathematical Eqs. (8) to (10) were formulated to encompass all the parameters stated. However, the economic model assumes no fiscal regimes and Table 4 shows the parameters used in calculating the NPV.

$$NCF = (N_p \times O_{PRICE} + G_p \times G_{PRICE}) - (CAPEX + OPEX + W_p \times W_{COST}) \quad (8)$$

$$PV_{(YEARLY)} = \frac{NCF}{(1+i)^n} \quad (9)$$

$$NPV = \sum_{n=0}^{20} \frac{NCF}{(1+i)^n} \quad (10)$$

where

$N_p$  = cumulative yearly oil production (stb)

**Table 3.** Skin and oil-water contact values for the three cases.

Skin		
Best case	Base case	Worst case
-2	0	+5
Oil-Water contact (ft)		
3,595	3,540	3,518

**Table 4.** Economic model parameters.

Parameters	Value	Unit
Drill and complete intelligent well cost	120,000,000	\$/well
OPEX, %Revenue	5 %	
Commodity desk		
Water treatment cost	4	\$/bbl
Price of oil	71.09	\$/bbl
Price of gas	2.712	\$/Mscf
Discount rate	10	%

$O_{PRICE}$  = average oil price over the year (\$/stb)

$G_p$  = cumulative yearly gas production (MSCF)

$G_{PRICE}$  = average gas price over the year (\$/MSCF)

$CAPEX$  = capital expenditure for drilling and completing IWC (\$)

$OPEX$  = field operating expenditure (\$)

$W_p$  = cumulative yearly water production (bbls)

$W_{COST}$  = average water treatment cost (\$/bbls)

$NCF$  = net cash flow (\$)

$PV$  = present value (\$)

$i$  = discount rate (effective) (%)

$n$  = number of interest compounding periods

$NPV$  = net present value (\$)

Average prices of commodities as of 10th April 2019 were obtained from oilpricewidget.com (Anon, 2019) and used in the economic model. The cost of drilling and completing the intelligent well took into account the cost of installing ICVs as well.

## 3. Results and discussion

### 3.1 Algorithms comparison and analysis

The three developed algorithms were put into the reservoir model and simulation was carried out for 20 years. The cumulative oil produced (FOPT) from the three algorithms is shown in Table 5. The algorithm that yielded the highest cumulative oil was considered the best because it will lead to the highest NPV. Algorithm 3 yielded the maximum cumulative oil amongst the three proposed algorithms for the given well parameter in this research. This can serve as a basis for predicting the optimisation of oil production from other wells. Hence it was chosen to be the optimal and most effective amongst the three proposed algorithms. The selected algorithm was later on, compared with a conventional production model to determine its optimality.

**Table 5.** Field oil production total comparison of algorithms.

Algorithm number	FOPT (bbls)
1	2,528,524.0
2	2,534,880.8
3	2,579,034.3

**Table 6.** Intelligent well versus conventional well.

Well type	FOPT (bbls)	FGPT (Mscf)	FWPT (bbls)
Conventional well	2,443,476.5	35,059,240.0	3,361,211.8
Intelligent well	2,579,034.3	35,120,676.0	3,020,343.8

### 3.2 Intelligent well completion results and analysis

In order to determine the effectiveness of the selected algorithm, the algorithm coupled with IWC was compared with conventional well. Field parameters such as FOPT also known as the cumulative oil production, field gas production total (FGPT) and field water production total (FWPT) for the intelligent well coupled with the developed algorithm was compared with the conventional well and the results are shown Table 6.

From the Table 6, it was observed that, the conventional well (horizontal well) without ICVs and a proper reactive strategy produced more water (3,361,211.8 bbls) than the intelligent well coupled with the developed RCS (algorithm 3) which produced 3,020,343.8 bbls of water. Again, there was an optimisation in the cumulative oil produced when an intelligent well was used in the oil rim reservoir. Fig. 9 shows a FOPT comparison of the intelligent well coupled with algorithm 3 and a conventional well. The graph was obtained from the result viewer of the ECLIPSE simulator software.

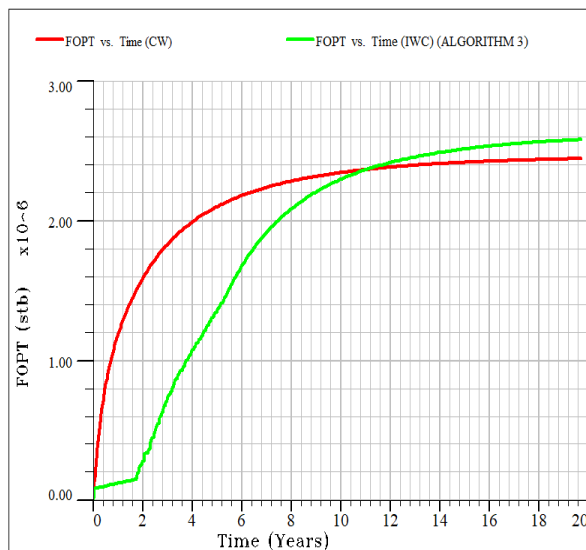

**Fig. 9.** Comparison of FOPT from IWC and CW.

From Fig. 9, it was observed that the developed algorithm 3 minimised oil production at the early years of production and increased it at the latter years, surpassing that of the conventional well by 135,557.8 bbls. This was because, at the early years of production, there was massive water and gas measurement at several segments and so the algorithm 3 had manage it by closing the ICVs to prevent its influx into the wellbore. The Intelligent Well (IW) that was producing based on algorithm 3, produced 2,579,034.3 bbls of oil whereas the conventional well produced 2,443,476.5 bbls of oil (Table 6). This indicates an increase in oil production for the IW due to RCS.

Fig. 10 shows FGPT comparison of IWC and CW. From Fig. 10, with regards to gas production, the intelligent well produced a cumulative gas of 35,120,676 Mscf whereas the conventional well gave a cumulative gas production of 35,059,240 Mscf (Table 6). Despite the slightly higher gas production in the intelligent well, the intelligent well delayed its gas production at a lower rate than the conventional well for about 12 years, so as to use its gas cap drive mechanism to provide energy for the oil recovery. From the 14th year, the cumulative gas production of the intelligent well peaked to match with the CW, and later surpassing it to yield a slightly higher cumulative gas production. In order to ascertain the impact of reinjection of the produced gas, gas injection simulation was carried out on the IWC and the results obtained indicated a large increase in the cumulative oil production (4,329,942.5 bbls), cumulative gas production (65,772,400 MScf) and cumulative water production (7,619,186.5 bbls) (Fig. 10).

Fig. 11 shows a graph of cumulative water of the CW and IWC. From Fig. 11, the intelligent well also decreased the Field Water Production Total (FWPT). The cumulative water produced from the conventional well was 3,361,211.8 bbls and 3,020,343.8 bbls from the IWC as shown in Table 6, which is about 10.14% reduction in produced water for the IWC.

From the Fig. 11, it is observed that, the IWC increased

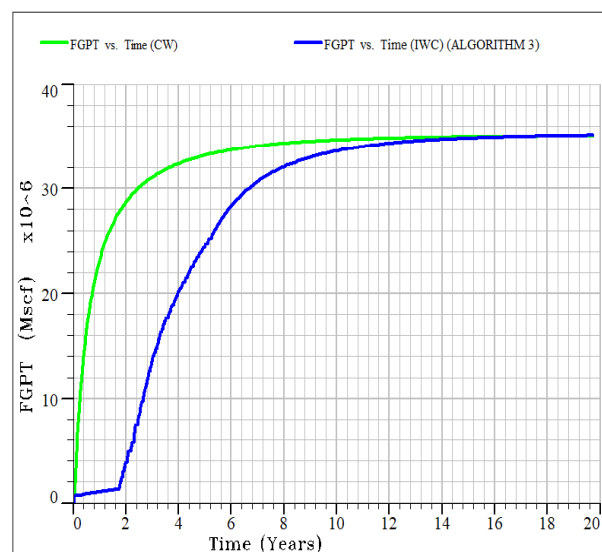

**Fig. 10.** Comparison of FGPT from IWC and CW.

**Table 7.** FOPTs and FOEs after permeability variations.

Field parameters	Best case scenario (high permeability case)		Worst case scenario (low permeability case)	
	CW	IWC	CW	IWC
FOE	0.095	0.101	0.087	0.090
FOPT	2,532	2,668	2,321	2,413
(bbls)	615.3	623.5	028	758

**Table 8.** FOPTs and FOEs after porosity variations.

Field parameters	Best case scenario (high porosity case)		Worst case scenario (low porosity case)	
	CW	IWC	CW	IWC
FOE	0.088	0.089	0.092	0.100
FOPT	4,681,421	4,764,500	1,230,266	1,333,927
(bbls)	-	-	-	-

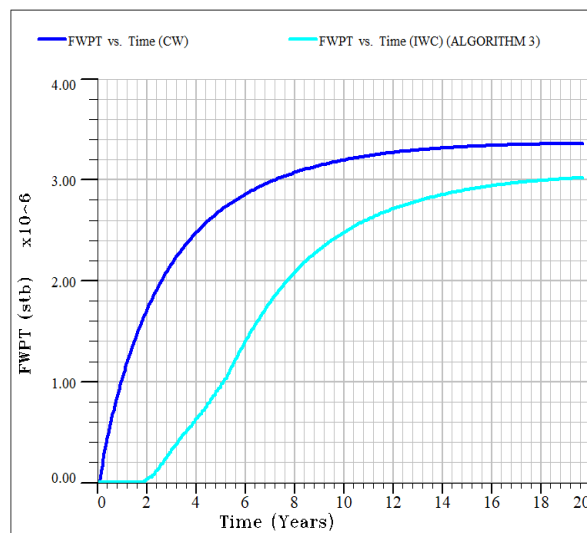
**Fig. 11.** FWPT comparison of IWC and CW.

the water breakthrough time to about 2 years (730 days) unlike the convention well whose breakthrough time occurred within a month. The delay in water breakthrough time was due to the shutting of the ICVs during the period that massive water production was eminent.

### 3.3 Sensitivity pattern results and analysis

The results obtained from varying porosity, permeability, oil water contact and skin so as to determine how robust algorithm 3 is, in relation to these variations are tabulated and discussed under this section.

#### 3.3.1 Results of sensitivity of absolute permeability

The results after obtaining the best and worst case by multiplying the base case porosity (the porosity of the reservoir

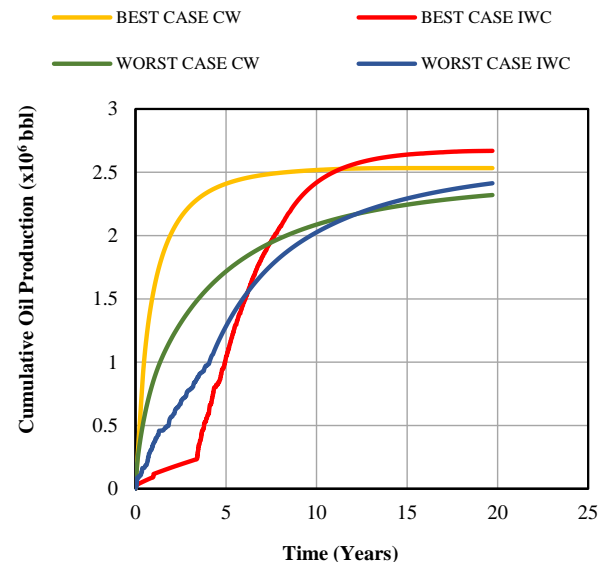
**Fig. 12.** FOPT comparison of IWC and CW under permeability variations.

which has been previously modelled) by a factor of 2 and 0.5 respectively is presented in Table 7. The FOPT and FOE of the two extremes are illustrated in Table 7. The intelligent well coupled with algorithm 3 yielded higher FOE and FOPT than the conventional well in both the best case and worst case scenarios. This indicates how robust the algorithm 3 is even under varying permeability of the oil rim reservoir. This ultimately means that, the developed RCS will function better than a conventional well even when the oil rim reservoir has an absolute permeability as low as 15 mD and as high as 60 mD. Fig. 9 shows the graphical representation of Table 7.

From Fig. 12, it was observed that, the developed algorithm functioned more effectively under the best case, thus high permeability. This is attributed to the fact that an increase in permeability increases flow rate and consequently leads to higher cumulative production. The IW produced 136,008

**Table 9.** Productivity index variations of IWC over 20-year period.

Skin factor	Parameter	5 years	10 years	15 years	20 years
0	Base case PI	8.06	5.71	6.08	8.50
5	Worst case PI	4.64	4.82	5.69	8.86
-2	Best case PI	84.77	10.18	9.87	12.24

(5.37%) bbls of oil more than the conventional well in high permeability case and 93,730 (4.04%) bbls more than the CW for low permeability case. This establishes that, the IWC coupled with the proposed algorithm 3 will be more effective in high permeability oil rim reservoirs. For high permeability oil rim reservoirs, fluids are transmitted easily to the ICVs. The algorithm 3 is designed in a way that the more fluids, specifically, water and gas get to the ICVs the more the ICV generates pressure drop to equalize the high velocity of the fluids, hence functioning more actively. The algorithm has the ability to curtail the massive water and gas breakthrough associated with high permeability rim reservoirs at early stage.

### 3.3.2 Results of sensitivity of absolute porosity

The robustness of the developed algorithm 3 after varying the absolute porosity of the reservoir for the two extremes (best and worst case) is detailed under this section. The FOPT and FOE of the best case and worst case for the IW and the CW are compared and presented in Table 8. The best case porosity value was obtained by multiplying the base case porosity by a factor of 2 and the worst case by a factor of 0.5.

From Table 8, the algorithm 3 fared better than the conventional well in both cases. It yielded higher FOE and FOPT than the conventional well. However, one striking observation was that, unlike the permeability where the best cases resulted in higher FOEs for both conventional and intelligent well, best case porosity case gave the lower values of FOEs in the oil rim reservoir. That is, FOE for conventional and intelligent wells are 0.088 and 0.089, respectively for high absolute porosity case but increases to 0.092 and 0.100 for CW and IWC in low absolute porosity case.

Algorithm 3 is robust in the case of both high and low absolute porosities since the cumulative oil produced in both cases were more than that from a conventional well. The algorithm was able to withstand the high and low porosity cases because this static parameter generally describes the voidage within the formations which in turn tells how much oil is in place. When in either high or small accumulations, the algorithm is able to shut the ICVs to prevent more water influx and open when oil accumulates in higher proportions in the segments unlike the case of convention wells that would produce more water and less oil due to lack of control. Fig. 13 shows the graph pertaining to the porosity variation for the CV and IWC.

### 3.3.3 Results of sensitivity of skin variations

The results obtained from varying the skin values from the base case skin factor of 0 to a best case skin value of -2 and

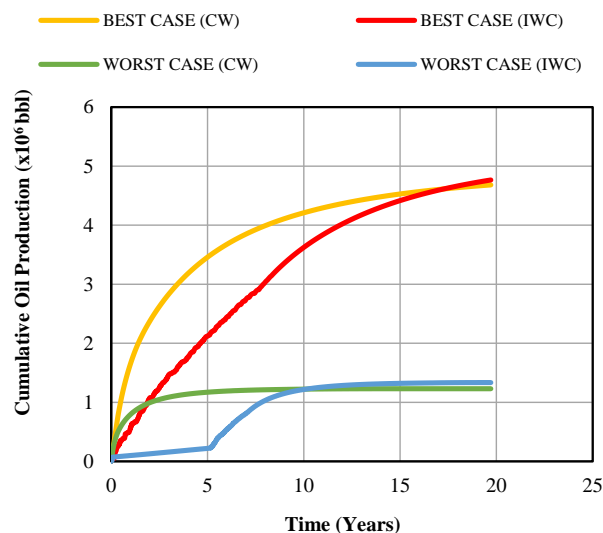
**Fig. 13.** FOPT comparison of IWC and CW under porosity variations.

worst case skin factor of +5 were analysed in terms of Productivity Index (PI) over a five-year period. This is because, this dynamic property changes with time and so there is a need to monitor its effect on PI which has a direct relation with skin. The best case and worst case values of -2 and +5, respectively, were chosen because they represented the allowable values that will not cause convergence problems to the software. The problem results when the effective wellbore radius increases and approaches the pressure equivalent grid radius. The algorithm 3 yielded the following values of PI of the well for each 5-year interval over 20 years and it is shown in Table 9.

From Table 9, the algorithm 3 functioned best over the first 5 years and poorly in the next 15 years for the best case. The extremely high PI value of 84.77 could be attributed to the fact that, stimulation increases the PI value of a well, more especially during the early stages of production after the stimulation had just been carried out. The best (highest) PI recorded for the worst case scenario (skin factor of 5) is obtained in 15 years, and it has a value of 5.69 and the minimum PI recorded during the first 5 years. Therefore, algorithm 3 yields higher PI values under any form of stimulation that will reduce skin, than when not stimulated or when there is wellbore damage.

### 3.3.4 Variations of oil-water contact

The oil water contact depth was varied so as to determine how the size of the aquifer will affect the cumulative oil production and cumulative water production. The results of

**Table 10.** FOPTs and FWPTs with variations in oil water contact.

Field parameter	Best case scenario (OWC-3595 ft)		Worst case scenario (OWC-3,518 ft)	
	CW	IWC	CW	IWC
FWPT (BBLs)	2,494.06	2,308.21	4,162,732	3,644,840
FOPT (BBLs)	1,254,225	1,196,975	343,822	296,851
(BBLs)	0	0	9	8

**Table 11.** Profitability results.

Project type	Net present value (\$)	Present value ratio
IWC	145,015,195.07	12.08

the variations are shown in Table 10.

The intelligent well under varying OWC for both cases yielded lower cumulative water but could not yield maximum cumulative oil. This was due to the fact that, the aquifer was inactive, hence could not yield maximum cumulative oil. For oil water contact at 3,595 ft, water control by the ICV was very effective because it led to little water production from the reservoir. IWC produced 2,308.21 bbls of water and CW produced 2,494.06 bbls as shown in Table 10. The difference of about 186 bbls of water, as compared to the difference of 517,892 bbls of water in the case of oil water contact at 3,518 ft. In the worst case scenario, the OWC is closer to the well resulting in an early water breakthrough which occurred within 35 days, hence higher water production rate.

### 3.4 Intelligent well profitability

The viability of the project after the NPV evaluation using the economic model parameters in Table 4. The computations were done using Excel Spreadsheet. In order to account for the uncertainties in oil price, which can rise and fall with time, an underlying assumption was made that, the oil price remained constant. The intelligent well project after the calculations yielded an NPV of \$145,015,195.07 which is greater than zero. Therefore, the application of the intelligent well in oil rim reservoirs for the study is economical (Broni-Bediako, 2018). In order to further validate the profitability, present value ratio (PVR) calculations was also done and it resulted in a PVR value of 12.08 which indicates that the project was economical.

## 4. Conclusions and recommendations

The results of the research indicated that, a well can be made intelligent when installed with ICVs and with a proper RCS. This is evident from the results obtained from the intelligent well coupled with “algorithm 3” where the intelligent well yielded higher cumulative oil production as against the conventional well. It can also be concluded that, the developed RCS is robust under varying reservoir conditions of porosity, permeability and skin but unrobust for the case of varying oil-

water contact since the CW yielded more cumulative oil than the IWC under this particular case.

It was established that, intelligent wells function better in terms of reducing water production in edge water drive reservoirs with thin pay zones (oil rims) than those with thick pay zones where coning occurs much later during the life of the field. This is evident from the results obtained from OWC at 3,518 ft. At this OWC, the oil column was very thin (13 ft) and this resulted in the intelligent well performing much function of reducing water production to more than half a million barrels as compared to OWC at 3,595 ft where the intelligent well reduces water production by just 186 bbls.

It is recommended that further work should be done on the technical feasibility of IW in oil rim reservoirs using optimisation algorithms such as Genetic Algorithm, PSO etc. In addition, local grid refinement should be considered when modelling near wellbore regions in future studies so as to clearly visualise the coning phenomenon.

## Acknowledgments

The authors would like to thank University of Mines and Technology, Tarkwa, Ghana for supporting this research and also thank the Editor-in-Chief and all the reviewers for giving valuable comments to improve upon this paper.

**Open Access** This article is distributed under the terms and conditions of the Creative Commons Attribution (CC BY-NC-ND) license, which permits unrestricted use, distribution, and reproduction in any medium, provided the original work is properly cited.

## References

- Adekunle, O.A. Intelligent well applications in production wells. Aberdeen, University of Aberdeen, 2012.
- Adusu, P.T. Optimising candidate well selection for matrix stimulation-IPR approach. Paper SPE-198707-MS Presented at SPE Nigeria Annual International Conference and Exhibition, Lagos, Nigeria, 5-7 August, 2019.
- Aitokhuehi, L. Real-time optimization of smart wells. California, Stanford University, 2004.
- Al-Ghareeb, Z.M. Monitoring and control of smart wells. California, Stanford University, 2009.
- Amangaliyev, B. Advance workover modelling tool using 3D models. SIS Software Bulletin in Caspian Region, 2017.
- Anon. [Controlling excess water production](#).
- Anon. [Oil and gas live overview](#).
- Aulisa, E., Bloshanskaya, L., Ibragimov, A. Long term dynamics for well productivity index for nonlinear flows in porous media. *J. Math. Phys.* 2011, 52(2): 1-26.

- Broni-Bediako, E. Oil and gas project evaluation. Tarkwa, University of Mines and Technology, 2018.
- Chang, Y.L. Simulation study on improved oil recovery for thin oil rims. Bandar Seri Iskandar, Universiti Teknologi PETRONAS, 2014.
- Dilib, F.A., Jackson, M.D., Mojaddam Zadeh, A., et al. Closed-loop feedback control in intelligent wells: Application to a heterogeneous, thin oil-rim reservoir in the North Sea. *SPE Reserv. Eval. Eng.* 2015, 18(1): 69-83.
- Huang, Z., Li, Y., Peng, Y., et al. Study of intelligent wells for liaohe field. *Proc. Eng.* 2011, 15: 739-743.
- Kumar, M., Sharma, P., Gupta, D.K. Completion design optimization of multilateral well to maximize hydrocarbon production in bottom water drive reservoirs. *Int. J. Eng. Dev. Res.* 2016, 4(2): 897-906.
- Mahmood, N., Sultan, Z., Yousof, N. A review on smart well completion system: route to the smartest recovery. International Conference on Petroleum Engineering, Dhaka, Bangladesh, 2016.
- Masoudi, R., Karkooti, H., Othman, M.B. How to get most out of your oil rim. 6th International Petroleum Technology Conference, Beijing, China, 26-28 March, 2013.
- Muhammad, B.R. Pressure as an indicator for water Break-through for horizontal well completion. Bandar Seri Iskandar, Universiti Teknologi PETRONAS, 2008.
- Pinto, M.A.S., Barreto, C.E., Schiozer, D.J. Optimization of proactive control valves of producer and injector intelligent wells under economic uncertainty. Paper SPE-154511-MS Presented at SPE Europec/EAGE Annual Conference, Copenhagen, Denmark, 4-7 June, 2012.
- Raoufi, M.H., Farasat, A., Mohammadifard, M. Application of simulated annealing optimization algorithm to optimal operation of intelligent well completions in an offshore Oil reservoir. *J. Pet. Exp. Prod. Technol.* 2015, 5(3): 327-338.
- Raoufi, M.H., Mashishi, M. Optimization of flow control with intelligent well completions in a channelized thin oil rim. 73rd European Association of Geoscientists and Engineers Conference and Exhibition Incorporating SPE EUROPEC, Vienna, Austria, 23-26 May, 2011.
- Robinson, M. Intelligent wells completions. *J. Pet. Technol.* 2003, 55(8): 57-59.
- Sarkodie, K., Afari, S.A., Aggrey, W.N. Intelligent well technology-dealing with gas coning problems in production wells. *Int. J. Appl.* 2014, 4(5): 121-135.
- Tarek, A. Reservoir Engineering Handbook 4th edition. UK, Elsevier Inc, 2010.